

F 012 410 000

Stand } 06-12-20
Issue }

Fig./Abb. 1

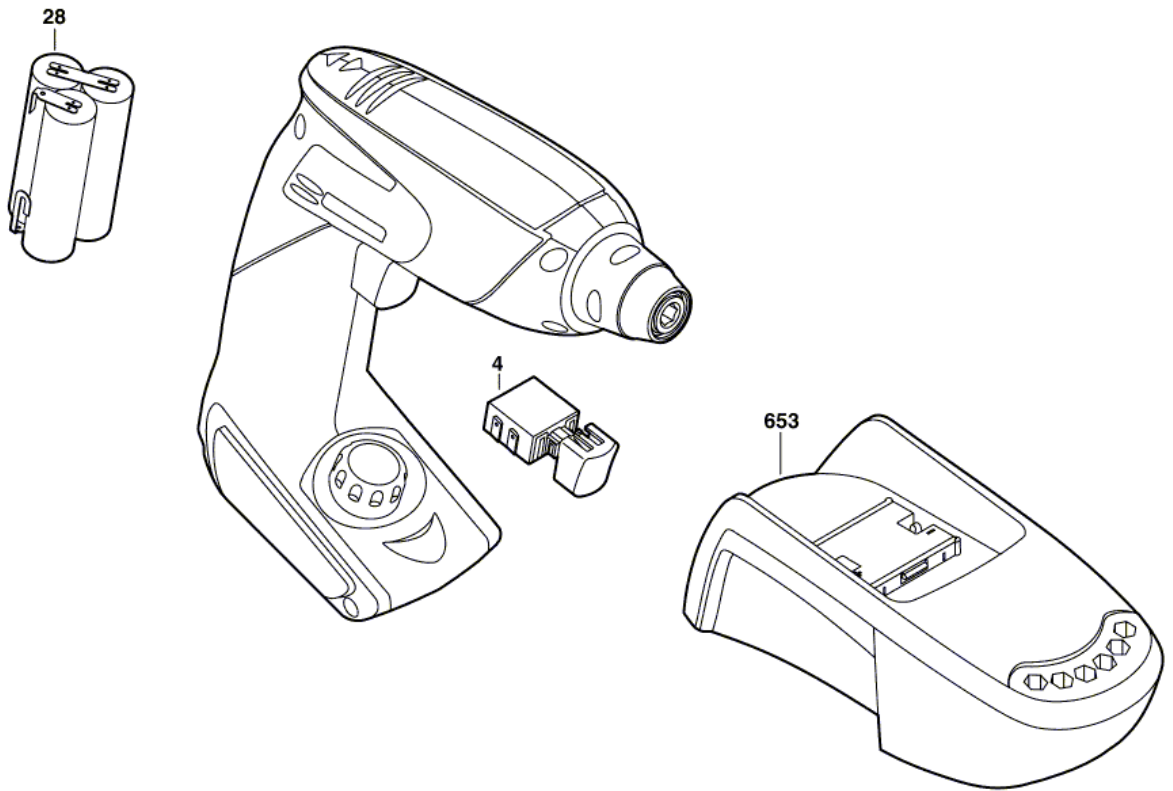

Änderungen vorbehalten
Modifications reserved
Modifications reserves
Salvo modificaciones